

KTFD-29

OPERATING
INSTRUCTION

OPERATING INSTRUCTION

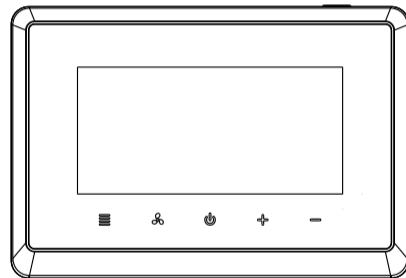

KTFD-29

Introducción del producto

Especificaciones ----- 02

Apariencia del termostato ----- 03

Instalación y Programación

Instalación del termostato ----- 04

Primera configuración ----- 05

Configuración del sistema ----- 06

El diagrama de cableado ----- 08

Configuración de programación ----- 12

Ajuste de velocidad del ventilador ----- 21

Modos de enfriamiento y calefacción ----- 22

Bloqueo infantil ----- 23

Menú de configuración ----- 24

Advertencia de error ----- 37

Ventana / Tarjeta de habitación ----- 37

KTFD-29

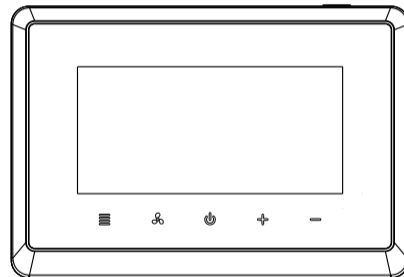

Especificaciones

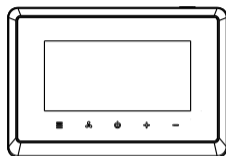

(KTFD-29)
thermostat

- Fuente de energía: 100-240VAC 50 / 60Hz
18-30VAC 50 / 60Hz
- Clasificación IP: IP21
- Rango de ajuste de temperatura: 5 °C ~ 35 °C
- Precisión de ajuste de temperatura: 0.5 °C
- Rango de visualización de temperatura: 0 °C ~ 50 °C
- Precisión de temperatura: 0.1 °C
- Rango de temperatura de operación: 0 °C ~ 50 °C
- Temperatura de envío y almacenamiento: -10 °C ~ 60 °C
- Salida: Rele Ventilador. carga I_{max} 250V / 8 (5) A
Compresor / Válvula Relé Carga I_{max} 250V / 5 (3) A

Apariencia del termostato

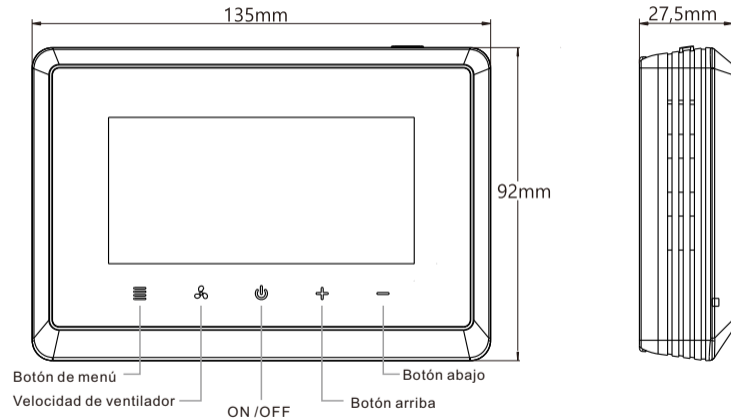

Instalación del termostato

1. Desatornille el terminal de protección de la cubierta y luego cableado.

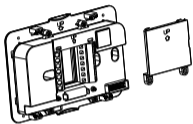

2. Después de cableado, tapa el terminal con la cubierta protectora, instale el tornillo.

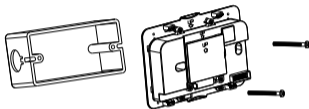

3. Instale y fije la base, incrustar en el módulo de visualización.

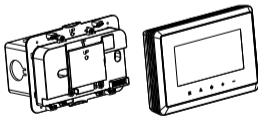

4. Instalación terminada.

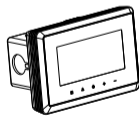

Ajuste por primera vez

Establezca la hora actual actual y la semana.

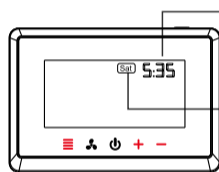

Configuración de la hora: presione “+” o “-” para ajustar la hora, presione brevemente “☰” y cambie a la configuración de la semana.

Configuración de la hora: presione “+” o “-” para ajustar la hora, presione brevemente “☰” y cambie a la configuración de la semana.

Configuración del sistema

(Sistema de elección de función)

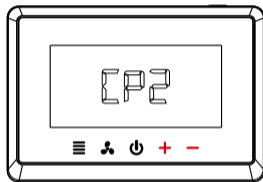

1. Presione "+" o "-" para
Seleccione el sistema primario.
CP1: sistema DX de una etapa
CP2: sistema DX de dos etapas
VENTILADOR: sistema de fan coil

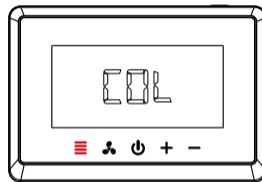

2. Presione "☰" para confirmar
la selección y cambiar a la selección
del sistema secundario.
COL: sistema de enfriamiento
TODOS: sistema de calor / frío

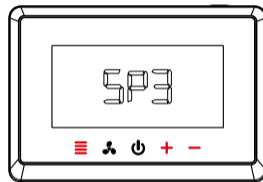

3. Seleccione los sistemas secundarios y
terciarios de la misma manera que arriba.
(Si es necesario seleccionar el sistema
terciario)
SP1: ventilador de una velocidad
SP3: ventilador de 3 velocidades

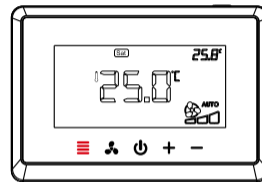

4. Configuración del sistema
completada, presione "☰"
para volver a la interfaz principal

El diagrama de cableado

Diagrama de cableado diferente corresponde a diferentes sistemas

Aplicación 1:
Ventilador de 3 velocidades /
sistema DX de dos etapas
(selección del sistema: CP2-COL-SP3)

Aplicación 2:
Ventilador de 3 velocidades /
sistema DX de una etapa
(selección del sistema: CP1-SP3)

Aplicación 3:
ventilador de una velocidad /
sistema DX de una etapa
(selección del sistema: CP1-SP1)

Aplicación 4:
ventilador de una velocidad /
sistema DX de dos etapas
(selección del sistema: CP2-COL-SP1)

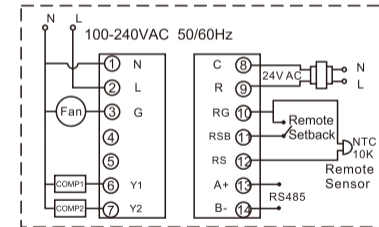
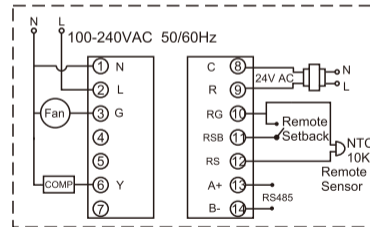
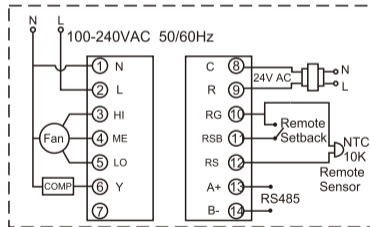
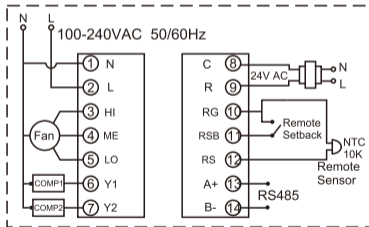

Aplicación 5:
 ventilador de una velocidad /
 2 sistema de calor / frío
 (selección del sistema: CP2-ALL)

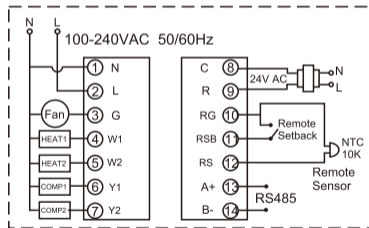

Aplicación 6:
 Sistema de fan coil de 2 tubos
 / 3 cables
 (selección del sistema: FAN-FA2)

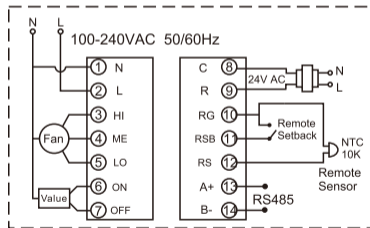

Aplicación 7:
 Sistema de fan coil de 4 tubos
 / 2 cables
 (selección del sistema: FAN-FA4)

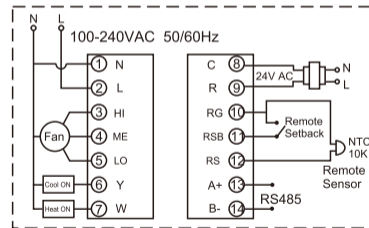

Aplicación 8:
 Single cool / Sistema de bobina de
 ventilador de 3 cables
 (selección del sistema: FAN-COL)

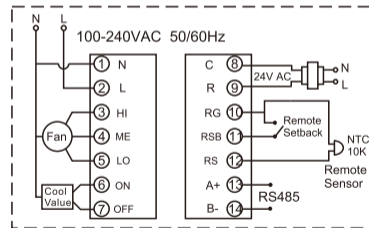

Configuraciones de programación

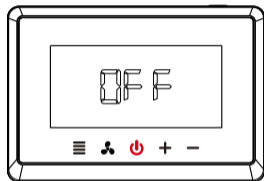

1. Presione brevemente el botón de encendido "  ", y luego la pantalla muestra "OFF".



2. Mantenga presionado el botón de menú "  " durante 5 segundos hasta que se muestre la interfaz de selección del sistema y seleccione la configuración del sistema previamente.

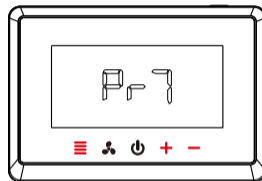



3. Después de seleccionar el sistema, seleccione el modo de programación: presione "+" o "-" para cambiar el modo de programación (Pr0 / Pr2 / Pr7), y presione "  " para confirmar y guardar las opciones.

Pr0: no programable

Pr2: días laborables + viernes y sábado

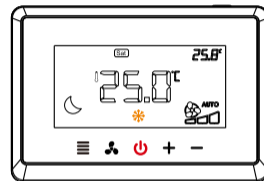
Pr7: 7 días programando individualmente



4. Presione brevemente el botón de encendido "  ", y la pantalla muestra "OFF", luego presione brevemente el botón de encendido "  " nuevamente para ingresar a la interfaz principal de programación

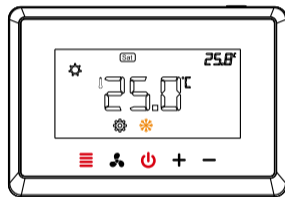

5. Mantenga presionado el botón de menú "☰" durante 5 segundos para ingresar a la configuración de programación. mantenga todas las luces de los botones encendidas antes de realizar esta operación; de lo contrario, presione "⏻"

Programación de 7 días: ajuste de tiempo / temperatura

Ajustes de programación separados para cada día (Pr7)
 (la configuración de programación es diferente de domingo a lunes)
 Hay 4 periodos cada día por defecto temperatura

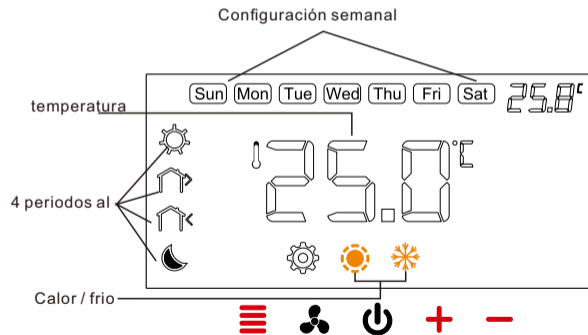







1. Configuración semanal
2. Configuración de tiempo
3. ajuste de temperatura

presione "+" "-" para ajustar la semana / hora / temperatura, presione brevemente "☰" para guardar la configuración y cambiar a la configuración del siguiente periodo.





mantenga presionado "☰" durante 5 segundos para cambiar el modo de calefacción o el modo de refrigeración

Ajuste predeterminado (calefacción)

week periods	Sun	Mon	Tue	Wed	Thu	Fri	Sat
 6:00 Morning	22°C	22°C	22°C	22°C	22°C	22°C	22°C
 8:00 Out door	16°C	16°C	16°C	16°C	16°C	16°C	16°C
 18:00 Back home	22°C	22°C	22°C	22°C	22°C	22°C	22°C
 22:00 Night	16°C	16°C	16°C	16°C	16°C	16°C	16°C

- ✳ Salga de la configuración de programación: presione brevemente el botón de encendido “”
Regrese al paso anterior: presione brevemente el botón de velocidad del ventilador “”

Ajuste predeterminado (enfriamiento)

week periods	Sun	Mon	Tue	Wed	Thu	Fri	Sat
 6:00 Morning	25°C	25°C	25°C	25°C	25°C	25°C	25°C
 8:00 Out door	28°C	28°C	28°C	28°C	28°C	28°C	28°C
 18:00 Back home	25°C	25°C	25°C	25°C	25°C	25°C	25°C
 22:00 Night	28°C	28°C	28°C	28°C	28°C	28°C	28°C

- ✳ Restaurar la configuración predeterminada: mantenga presionado “+” y “-” durante más de 5 segundos hasta que la pantalla muestre “**DEF**” y el “**DEF**” parpadee 3 veces.

Programación de 2 períodos: ajuste de tiempo / temperatura

Hay dos períodos de tiempo para programar en una semana (Pr2)
 (período 1: de domingo a jueves temperatura
 período 2: de viernes a sábado)

Hay 4 períodos cada día por defecto

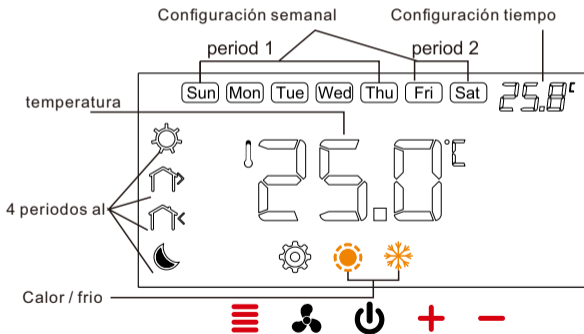

1. Configuración semanal
2. Configuración de tiempo
3. ajuste de temperatura

presione "+" "-" para ajustar la semana / hora / temperatura, presione brevemente "☰" para guardar la configuración y cambiar a la configuración del próximo período.

mantenga presionado "☰" durante 5 segundos para cambiar el modo de calefacción o el modo de refrigeración

Configuración predeterminada (calentamiento)

week periods	Sun	Mon	Tue	Wed	Thu	Fri	Sat
6:00 Morning			22°C			22°C	
8:00 Out door			16°C			16°C	
18:00 Back home			22°C			22°C	
22:00 Night			16°C			16°C	

* Salga de la configuración de programación: presione el botón de encendido "⏻"
 Regrese al paso anterior: presione brevemente el botón de velocidad del ventilador "🌀"

Ajuste predeterminado (enfriamiento)

week periods	Sun	Mon	Tue	Wed	Thu	Fri	Sat
6:00 Morning			25°C				25°C
8:00 Out door			28°C				28°C
18:00 Back home			25°C				25°C
22:00 Night			28°C				28°C



Restaurar la configuración predeterminada: mantenga presionado "+" y "-" durante más de 5 segundos hasta que la pantalla muestre "DEF" y el "DEF" parpadee 3 veces.

Ajuste de velocidad del ventilador

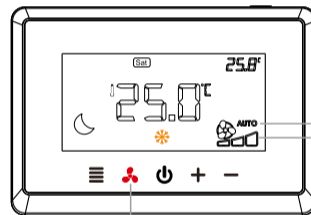

Configuración del modo de velocidad del ventilador: presione brevemente " " para cambiar el modo "AUTO" o "ON".

Modo de velocidad

Botón selección de velocidad

AUTO: modo automático (Alta velocidad, velocidad media, baja velocidad)
ON: modo manual

Modos de enfriamiento y calentamiento

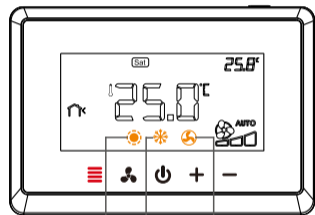

Presione brevemente el botón de menú “☰” para cambiar el modo de enfriamiento “☀️” o el modo de calefacción “☀️” o el modo de ventilador de velocidad única “🌀”

Velocidad única del ventilador
Modo ventilación
Modo calefacción

Bloqueo infantil



Seguro infantil

Presione los botones "+" y "-" durante 5 segundos al mismo tiempo para abrir / cerrar el bloqueo para niños “🔒”.

Menú de Configuración

La configuración del menú de ajustes:

1. En el estado de apagado, mantenga presionado el botón de menú "☰" durante 5 segundos para ingresar la configuración de programación de parámetros de configuración.
2. Presione "+" o "-" para seleccionar la configuración del parámetro de configuración, luego presione "☰" para guardar y cambiar a la siguiente configuración del elemento.
3. Después de configurar todos los parámetros, presione el botón de encendido "⏻" para salir de la configuración y volver a la etapa de apagado.

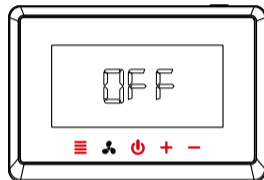

- * 1. El termostato saldrá de la configuración del parámetro de configuración automáticamente y volverá al estado de apagado si no se realiza ninguna operación durante 30 segundos.
- 2. Restablezca la configuración predeterminada: durante la configuración, mantenga presionado "+" y "-" durante más de 5 segundos hasta que la pantalla muestre "dEF" y el "dEF" parpadee 3 veces.

Menú de configuración: sistema Fancoil

Sistema de fan coil:

Aplicación 6: (página 10)
Sistema de fan coil de 2
tubos / 3 cables
(selección del sistema: FAN-FA2)

Aplicación 7: (página 11)
Sistema de fan coil de 4
tubos / 2 cables
(selección del sistema:
FAN-FA4)

Aplicación 8: (página 12)
Sistema de bobina de
ventilador de enfriamiento
único / 3 cables
(selección del sistema:
FAN-COL)

Parametro Item	Descripción	Opciones del parámetro	Por defecto
3	Programación	Pr0: no programable Pr2: días laborables + viernes y sábado Pr7: programa individual de 7 días	Pr0
4	Valor de ajuste de temperatura	-4°C~4°C	0
5	Temperatura máxima	24°C~35°C	30°C
6	Temperatura mínima	5°C~24°C	20°C
7	Desconectar la memoria	rE: recuperar memoria en el encendido rd: recuperar memoria apagado en el encendido	rE

Parametro Item	Descripción	Opciones del parámetro	Por defecto
8	Mostrar modo de luz de fondo	1: la luz de fondo es normal 2: la luz de fondo se mantendrá siempre encendida	2
9	Opción de parada del ventilador	ON OFF	ON
10	Temperatura de ahorro de energía para calefacción.	5°C~18°C	18°C
11	Temperatura de ahorro de energía para ventilación	25°C~30°C	28°C
12	Tarjeta de habitación / modo de tarjeta de ventana	SC: active el modo de energía de la tarjeta de sala mediante circuito abierto OC: activa el modo de energía de la tarjeta de la habitación por circuito cerrado SCC: active el modo de energía de la tarjeta de ventana por circuito abierto OCC: active el modo de energía de la tarjeta de ventana por circuito cerrado OO: cancelar la función de tarjeta de sala / ventana	SC
13	La válvula inicia las opciones de banda muerta	1°C~5°C	1°C

Parametro Item	Descripción	Opciones del parámetro	Por defecto
14	La válvula deja de ofrecer opciones	1°C~5°C	1°C
15	La dirección de 485	1~254	1

 No hay elemento 10 (temperatura de ahorro de energía para calefacción) para sistema de bobina de ventilador de enfriamiento individual / 3 cables (Aplicación 8, FAN-COIL)

Menú de configuración: sistema de compresor único

Sistema de compresor simple:

Aplicación 2: (página 8)

Ventilador de 3 velocidades /
sistema de compresor único
(selección del sistema: CP1-SP3)

Aplicación 3: (página 9)

ventilador de una velocidad /
sistema de compresor único
(selección del sistema: CP1-SP1)

Parametro Item	Descripción	Opciones del parámetro	Por defecto
3	Programación	Pr0: no programable Pr2: días laborables + viernes y sábado Pr7: programa individual de 7 días	Pr0
4	Valor de ajuste de temperatura	-4°C~4°C	0
5	Temperatura máxima	24°C~35°C	30°C
6	Temperatura mínima	5°C~24°C	20°C
7	Desconectar la memoria	rE: recuperar memoria en el encendido rd: recuperar memoria apagado en el encendido	rE

Parametro Item	Descripción	Opciones del parámetro	Por defecto
8	Mostrar modo de luz de fondo	1: la luz de fondo es normal 2: la luz de fondo se mantendrá siempre encendida	2
9	Temperatura de ahorro de energía para ventilación	25°C~30°C	28°C
10	Tarjeta de habitación / modo de tarjeta de ventana	SC: active el modo de energía de la tarjeta de sala mediante circuito abierto OC: activa el modo de energía de la tarjeta de la habitación por circuito cerrado SCC: active el modo de energía de la tarjeta de ventana por circuito abierto OCC: active el modo de energía de la tarjeta de ventana por circuito cerrado OO: cancelar la función de tarjeta de sala / ventana	SC
11	La válvula inicia las opciones de banda muerta	1°C~5°C	1°C
12	La válvula deja de correr opciones	1°C~5°C	1°C

Parametro Item	Descripción	Opciones del parámetro	Por defecto
13	Ajuste del ciclo de retardo de reinicio del compresor	0min~5min	3min
14	La dirección de 485	1~254	1

Menú de configuración: sistema de dos compresores

Dos compresores de refrigeración del sistema:

Aplicación 1: (página 8)

Ventilador de 3 velocidades /
sistema de dos compresores

(selección del sistema: CP2-COL-SP3)

Aplicación 4: (página9)

ventilador de una velocidad /
sistema de dos compresores

(selección del sistema: CP2-COL-SP1)

Parametro Item	Descripción	Opciones del parámetro	Por defecto
4	Programación	Pr0: no programable Pr2: días laborables + viernes y sábado Pr7: programa individual de 7 días	Pr0
5	Valor de ajuste de temperatura	-4°C~4°C	0
6	Temperatura máxima	24°C~35°C	30°C
7	Temperatura mínima	5°C~24°C	20°C
8	Desconectar la memoria	rE: recuperar memoria en el encendido rd: recuperar memoria apagado en el encendido	rE

Parametro Item	Descripción	Opciones del parámetro	Por defecto
9	Mostrar modo de luz de fondo	1: la luz de fondo es normal 2: la luz de fondo se mantendrá siempre encendida	2
10	Temperatura de ahorro de energía para ventilación	25°C~30°C	28°C
11	Tarjeta de habitación / modo de tarjeta de ventana	SC: active el modo de energía de la tarjeta de sala mediante circuito abierto OC: activa el modo de energía de la tarjeta de la habitación por circuito cerrado SCC: active el modo de energía de la tarjeta de ventana por circuito abierto OCC: active el modo de energía de la tarjeta de ventana por circuito cerrado OO: cancelar la función de tarjeta de sala / ventana	SC
12	La válvula inicia las opciones de banda muerta	1°C~5°C	1°C
13	La válvula deja de correr opciones	1°C~5°C	1°C

Parametro Item	Descripción	Opciones del parámetro	Por defecto
14	La primera válvula reinicia la configuración del ciclo de retardo	0min~5min	3 min
15	El segundo compresor inicia las opciones de banda muerta	1°C~5°C	1°C
16	Las opciones del segundo compresor dejan de funcionar	1°C~5°C	1°C
17	La segunda válvula reinicia la configuración del ciclo de retardo	0min~5min	3 min
18	La segunda válvula inicia la configuración del ciclo de retardo	0min~5min	1 min
19	La dirección de 485	1~254	1



Para los artículos 15 y 16, la temperatura de parada de funcionamiento no puede ser mayor que la temperatura inicial de la banda muerta

Sistema de dos compresores: calefacción / refrigeración:
 Aplicación 5: (página10)
 ventilador de una velocidad / 2 sistemas de calor / frío
 (selección del sistema: CP2-ALL)

Parametro Item	Descripción	Opciones del parámetro	Por defecto
3	Programación	Pr0: no programable Pr2: días laborables + viernes y sábado Pr7: programa individual de 7 días	Pr0
4	Valor de ajuste de temperatura	-4°C~4°C	0
5	Temperatura máxima	24°C~35°C	30°C
6	Temperatura mínima	5°C~24°C	20°C
7	Desconectar la memoria	rE: recuperar memoria en el encendido rd: recuperar memoria apagado en el encendido	rE

Parametro Item	Descripción	Opciones del parámetro	Por defecto
8	Mostrar modo de luz de fondo	1: la luz de fondo es normal 2: la luz de fondo se mantendrá siempre encendida	2
9	Temperatura de ahorro de energía para calefacción.	5°C~18°C	18°C
10	Temperatura de ahorro de energía para ventilación	25°C~30°C	28°C
11	Tarjeta de habitación / modo de tarjeta de ventana	SC: active el modo de energía de la tarjeta de sala mediante circuito abierto OC: activa el modo de energía de la tarjeta de la habitación por circuito cerrado SCC: active el modo de energía de la tarjeta de ventana por circuito abierto OCC: active el modo de energía de la tarjeta de ventana por circuito cerrado OO: cancelar la función de tarjeta de sala / ventana	SC
12	La válvula inicia las opciones de banda muerta	1°C~5°C	1°C

Parametro Item	Descripción	Opciones del parámetro	Por defecto
13	Las primeras opciones del compresor dejan de funcionar	1°C~5°C	1°C
14	La primera válvula reinicia la configuración del ciclo de retardo	0min~5min	3 min
15	El segundo compresor inicia las opciones de banda muerta	1°C~5°C	1°C
16	Las opciones del segundo compresor dejan de funcionar	1°C~5°C	1°C
17	La segunda válvula reinicia la configuración del ciclo de retardo	0min~5min	3 min
18	La segunda válvula inicia la configuración del ciclo de retardo	1min~5min	1 min
19	La dirección de 485	1~254	1

Advertencia de error



Temperatura ambiente (sensor interior de la habitación) roto o atajo, el termostato tendrá "Err"

Tarjeta de ventana / habitación

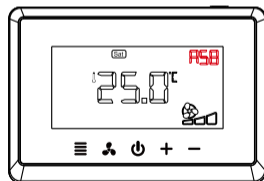

Función de tarjeta de ventana abierta, el termostato tendrá "ASB"

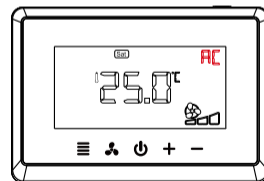

Función de tarjeta de habitación abierta, el termostato tendrá "AC"

Introdução do produto

Especificações ----- 02

Aparência do termostato ----- 03

Instalação e Programação

Instalação do termostato ----- 04

Primeira configuração ----- 05

Configuração do sistema ----- 06

Diagrama de fiação ----- 08

Configurações de programação ----- 12

Ajuste da velocidade do ventilador ----- 21

Modos de refrigeração e aquecimento ----- 22

Bloqueio infantil ----- 23

Menu de configuração ----- 24

Aviso de erro ----- 37

Cartão Janela / Sala ----- 37

KTFD-29

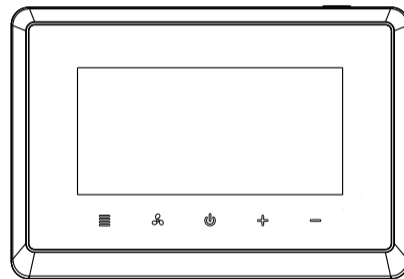

Especificações

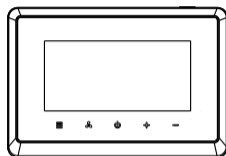

(KTFD-29)
thermostat

- Fonte de alimentação: 100-240VAC 50 / 60Hz
18-30VAC 50 / 60Hz
- Classificação IP: IP21
- Faixa de ajuste de temperatura: 5 °C ~ 35 °C
- Precisão de ajuste de temperatura: 0,5 °C
- Faixa de exibição de temperatura: 0 °C ~ 50 °C
- Precisão da temperatura: 0.1 °C
- Faixa de temperatura de operação: 0 °C ~ 50 °C
- Temperatura de envio e armazenamento: -10 °C ~ 60 °C
- Saída: Carga do relé do ventilador I_{max} 250V / 8 (5) A
Carga do relé do compressor / válvula I_{max} 250V / 5 (3) A

Aparência do termostato

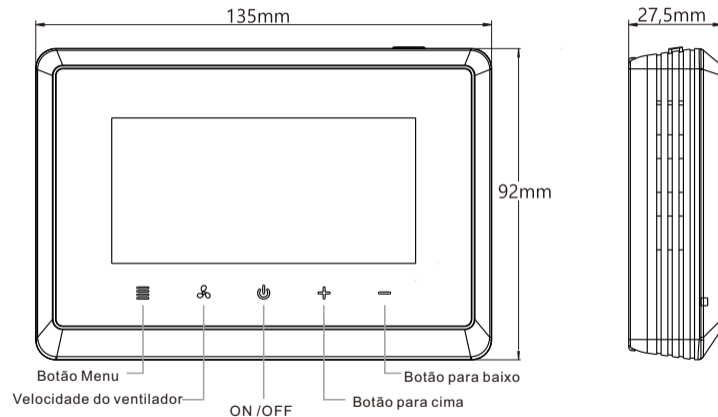

Instalação do termostato

1. Desaparafuse o terminal de proteção da tampa e depois a fição.

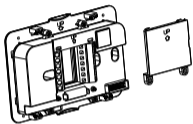

2. Após a fição, cubra o terminal com a tampa protetora, instale o parafuso.

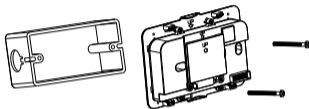

3. Instale e fixe a base, incorporar no módulo de exibição.

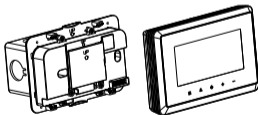

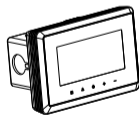

4. Instalação terminada.

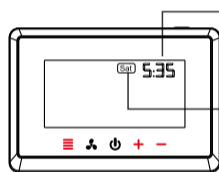

Ajuste pela primeira vez

Defina a hora atual e a semana.



Configuração da hora: pressione “+” ou “-” para definir a hora, pressione brevemente “” e mude para a configuração da semana.

Configuração da semana: pressione “+” ou “-” para ajustar a semana, pressione brevemente “” e mude para as configurações do sistema.

Configuração do sistema

(Sistema de escolha de funções)



1. Pressione "+" ou "-" para Seleção o sistema primário.
CP1: sistema DX de estágio único
CP2: sistema DX de dois estágios
VENTILADOR: sistema de ventiloconvectores

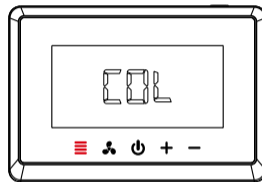

2. Pressione "☰" para confirmar a seleção e altere para a seleção do sistema secundário.
COL: sistema de refrigeração
TUDO: sistema de calor / frio

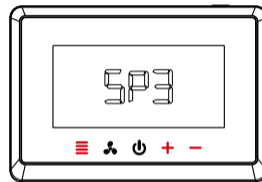

3. Selecione os sistemas secundário e terciário da mesma maneira que acima. (Se necessário, selecione o sistema terciário)
SP1: ventilador de uma velocidade
SP3: ventilador de 3 velocidades

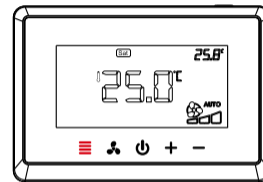

4. Configuração do sistema concluída, pressione "☰" para retornar à interface principal

Diagrama de fiação

Diagrama de fiação diferente corresponde a diferentes sistemas

Aplicação 1:
Ventilador de 3 velocidades /
sistema DX de dois estágios
(seleção do sistema: CP2-COL-SP3)

Aplicação 2:
Ventilador de 3 velocidades /
sistema DX de estágio único
(seleção do sistema: CP1-SP3)

Aplicação 3:
ventilador de uma velocidade /
sistema DX de estágio único
(seleção do sistema: CP1-SP1)

Aplicação 4:
ventilador de uma velocidade /
sistema DX de dois estágios
(seleção do sistema: CP2-COL-SP1)

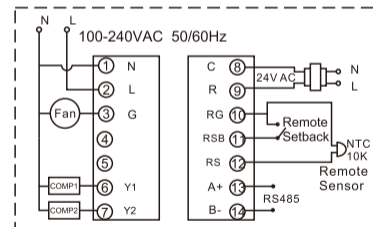
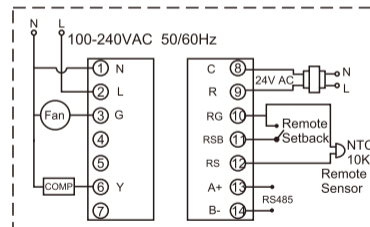
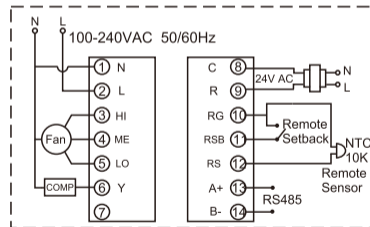
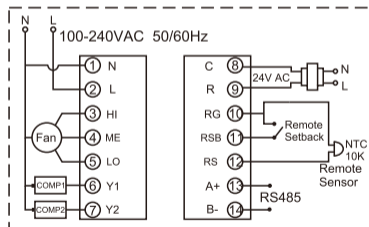

Aplicação 5:
ventilador de uma velocidade /
2 sistema de calor / frio
(seleção do sistema: CP2-ALL)

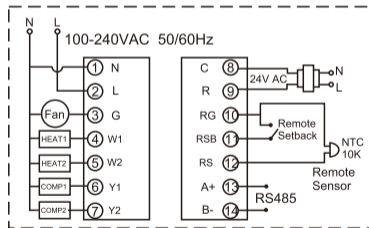

Aplicação 6:
Sistema de ventiloconvetor de
2 tubos / 3 fios
(seleção do sistema: FAN-FA2)

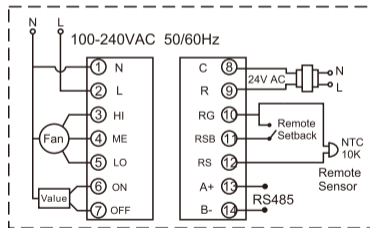

Aplicação 7:
Sistema de ventiloconvetor de
4 tubos / 2 fios
(seleção do sistema: FAN-FA4)

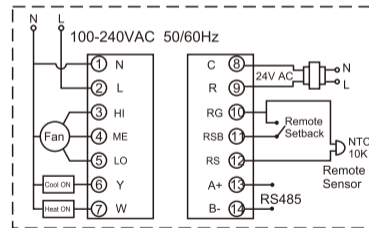

Aplicação 8:
Único frio /
Sistema de ventiloconvetor de 3 fios
(seleção do sistema: FAN-COL)

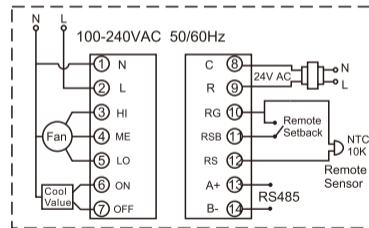

Configurações de programação

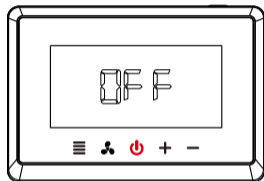

1. Pressione brevemente o botão liga / desliga "  " e, em seguida, o visor mostra "OFF".



2. Pressione e segure o botão "  " do menu por 5 segundos até que a interface de seleção do sistema seja exibida e selecione a configuração do sistema com antecedência.

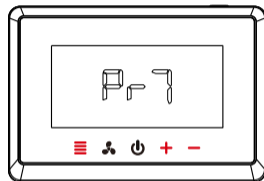



3. Após selecionar o sistema, selecione o modo de programação: pressione "+" ou "-" para alterar o modo de programação (Pr0 / Pr2 / Pr7) e pressione "  " para confirmar e salvar as opções.

Pr0: não programável

Pr2: dias úteis + sexta e sábado

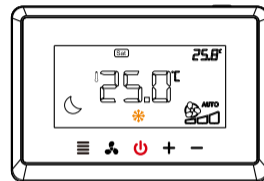
Pr7: 7 dias programando individualmente



4. Pressione brevemente o botão liga / desliga "  ", e o visor mostra "OFF"; depois pressione brevemente o botão liga / desliga "  " novamente para entrar na interface principal de programação

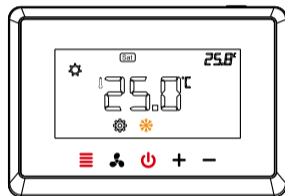

5. Pressione e segure o botão de menu "☰" por 5 segundos para inserir as configurações de programação. mantenha todas as luzes do botão acesas antes de executar esta operação; caso contrário, pressione "⏻"

Programação de 7 dias: ajuste de hora / temperatura

Configuração semanal Configurações de programação separadas para cada dia (Pr7)
 Configuração semanal
 (a configuração de programação é diferente de domingo a segunda-feira)
 Existem 4 períodos por dia por padrão



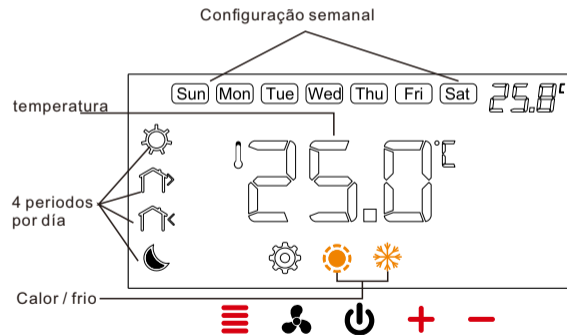

1. Configuração semanal
2. Configuração de tempo
3. Ajuste temperature





pressione "+" "-" para ajustar a semana / hora / temperatura, pressione brevemente "☰" para salvar a configuração e mudar para a próxima configuração de período.





pressione e segure "☰" por 5 segundos para alterar o modo de aquecimento ou o modo de refrigeração

Configuração padrão (aquecimento)

week periods	Sun	Mon	Tue	Wed	Thu	Fri	Sat
 6:00 Morning	22°C	22°C	22°C	22°C	22°C	22°C	22°C
 8:00 Out door	16°C	16°C	16°C	16°C	16°C	16°C	16°C
 18:00 Back home	22°C	22°C	22°C	22°C	22°C	22°C	22°C
 22:00 Night	16°C	16°C	16°C	16°C	16°C	16°C	16°C

✳ Saia das configurações de programação: pressione brevemente o botão liga / desliga “”
 Retorne ao passo anterior: pressione brevemente o botão de velocidade do ventilador “”

Configuração padrão (refrigeração)

week periods	Sun	Mon	Tue	Wed	Thu	Fri	Sat
 6:00 Morning	25°C	25°C	25°C	25°C	25°C	25°C	25°C
 8:00 Out door	28°C	28°C	28°C	28°C	28°C	28°C	28°C
 18:00 Back home	25°C	25°C	25°C	25°C	25°C	25°C	25°C
 22:00 Night	28°C	28°C	28°C	28°C	28°C	28°C	28°C

✳ Restaurar configurações padrão: mantenha pressionado "+" e "-" por mais de 5 segundos até que o visor mostre "DEF" e "DEF" pisque 3 vezes.

Programação de 2 períodos: ajuste de tempo / temperatura

temperatura Ajuste de tempo

Configuração semanal Há dois períodos para agendar em uma semana (Pr2)

(período 1: de domingo a quinta-feira

Período 2: sexta a sábado) 4 períodos por dia

Existem 4 períodos por dia por padrão

1. Configuração semanal
2. configuração de tempo
3. Ajuste temperature

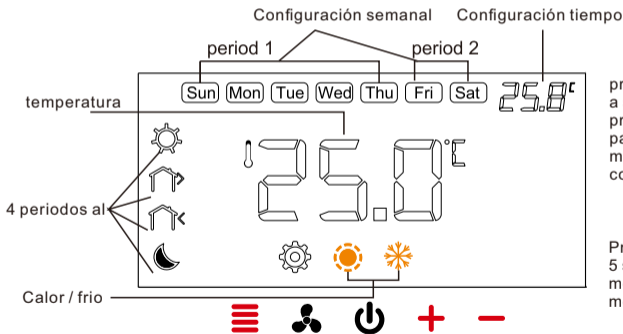

pressione "+" "-" para ajustar a semana / hora / temperatura, pressione brevemente "≡" para salvar a configuração e mudar para a próxima configuração de período.

Pressione e segure "≡" por 5 segundos para alterar o modo de aquecimento ou modo de refrigeração

Configuração padrão (aquecimento)

week periods	Sun	Mon	Tue	Wed	Thu	Fri	Sat
6:00 Morning			22°C				22°C
8:00 Out door			16°C				16°C
18:00 Back home			22°C				22°C
22:00 Night			16°C				16°C

* Saia das configurações de programação: pressione o botão liga / desliga "⏻" Retorne ao passo anterior: pressione brevemente o botão de velocidade do ventilador "🌀"

Configuração padrão (refrigeração)

week periods	Sun	Mon	Tue	Wed	Thu	Fri	Sat
6:00 Morning			25°C				25°C
8:00 Out door			28°C				28°C
18:00 Back home			25°C				25°C
22:00 Night			28°C				28°C

* Restaurar configurações padrão: mantenha pressionado "+" e "-" por mais de 5 segundos até que o visor mostre "DEF" e "DEF" pisque 3 vezes.

Ajuste da velocidade do ventilador

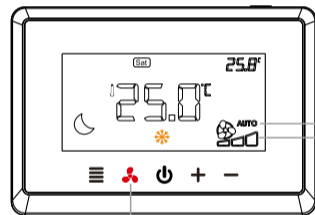

Configuração do modo de velocidade do ventilador: pressione brevemente " " para alterar o modo "AUTO" ou "ON".

Modo de velocidade

Botão de seleção de velocidade

AUTO: modo automático
(Alta velocidade, velocidade média, baixa velocidade)
ON: modo manual

Modos de refrigeração e aquecimento

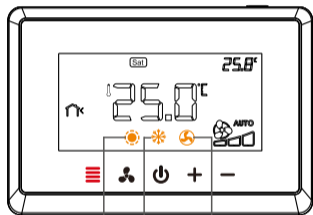

Pressione brevemente o botão de menu "☰" para alterar o modo de resfriamento "☀❄" ou o modo de aquecimento "☀🔥" ou o modo de ventilador de velocidade única "🌀"

Velocidade do ventilador único

Modo de ventilação

Modo de aquecimento

Bloqueio infantil

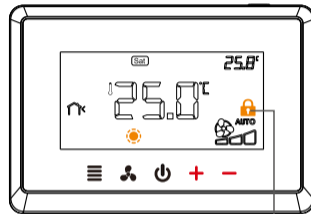

Seguro de criança

Pressione os botões "+" e "-" por 5 segundos ao mesmo tempo para abrir / fechar o bloqueio infantil "🔒".

Menu de configuração

A configuração do menu de configurações:

- 1.No estado de desligamento, pressione e mantenha pressionado o botão "☰" do menu por 5 segundos para inserir os parâmetros de programação das definições de configuração.
2. Pressione "+" ou "-" para selecionar o parâmetro de configuração, depois pressione "☰" para salvar e mudar para o próximo item.
3. Após configurar todos os parâmetros, pressione o botão "⏻" liga / desliga para sair da configuração e retornar ao estágio de desligamento.

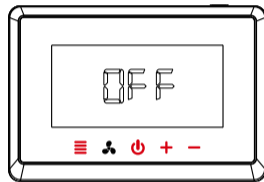

- * 1.O termostato sai automaticamente da definição dos parâmetros de configuração e retorna ao estado desligado se nenhuma operação for realizada por 30 segundos.
- 2. Redefina as configurações padrão: durante a configuração, pressione e segure "+" e "-" por mais de 5 segundos até que o visor mostre "dEF" e "dEF" pisque 3 vezes.

Menu de configuração: Sistema Fancoil

Sistema de ventiloconvectores:
Aplicativo 6: (página 10)
Sistema de ventiloconvetor de
2 tubos / 3 fios
(seleção do sistema: FAN-FA2)

Aplicativo 7: (página 11)
Sistema de ventiloconvetor
de 4 tubos / 2 fios
(seleção do sistema: FAN-FA4)

Aplicativo 8: (página 12)
Sistema de ventiloconvetor
único / 3 fios
(seleção do sistema: FAN-COL)

Parâmetro Item	Descrição do produto	Opções de Parâmetros	Por padrão
3	Programação	Pr0: não programável Pr2: dias úteis + sexta e sábado Pr7: programa individual de 7 dias	Pr0
4	Valor de ajuste da temperatura	-4°C~4°C	0
5	Temperatura máxima	24°C~35°C	30°C
6	Temperatura mínima	5°C~24°C	20°C
7	Desconectar memória	rE: recuperar memória ao ligar rd: recuperar a memória desligada ao ligar	rE

Parâmetro Item	Descrição do produto	Opções de Parâmetros	Por padrão
8	Mostrar modo de luz de fundo	1: a luz de fundo é normal 2: a luz de fundo sempre permanece acesa	2
9	Opção de parada do ventilador	ON OFF	ON
10	Temperatura de economia de energia para aquecimento.	5°C~18°C	18°C
11	Temperatura de economia de energia para ventilação	25°C~30°C	28°C
12	Modo de cartão de sala / cartão de janela	SC: ativa o modo de energia do cartão da sala por circuito aberto OC: ativa o modo de energia do cartão da sala por circuito fechado SCC: ativar o modo de energia da placa da janela de circuito aberto OCC: ativa o modo de energia da placa da janela de circuito fechado OO: cancela a função do cartão da sala / janela	SC
13	Válvula inicia opções de faixa morta	1°C~5°C	1°C

Parâmetro Item	Descrição do produto	Opções de Parâmetros	Por padrão
14	A válvula para de oferecer opções	1°C~5°C	1°C
15	O endereço de 485	1~254	1

 Nenhum elemento 10 (temperatura de economia de energia para aquecimento) para sistema de serpentina de ventilador de refrigeração individual / 3 fios (Aplicação 8, FAN-COIL)

Menu de configuração: sistema de compressor único

Sistema de compressor simples:

Aplicativo 2: (página 8)

Ventilador de 3 velocidades /
sistema de compressor único
(seleção do sistema: CP1-SP3)

Aplicativo 3: (página 9)

ventilador de uma velocidade /
sistema de compressor único
(seleção do sistema: CP1-SP1)

Parâmetro Item	Descrição do produto	Opções de Parâmetros	Por padrão
3	Programação	Pr0: não programável Pr2: dias úteis + sexta e sábado Pr7: programa individual de 7 dias	Pr0
4	Valor de ajuste da temperatura	-4°C~4°C	0
5	Temperatura máxima	24°C~35°C	30°C
6	Temperatura mínima	5°C~24°C	20°C
7	Desconectar memória	rE: recuperar memória ao ligar rd: recuperar a memória desligada ao ligar	rE

Parâmetro Item	Descrição do produto	Opções de Parâmetros	Por padrão
8	Mostrar modo de luz de fundo	1: a luz de fundo é normal 2: a luz de fundo sempre permanece acesa	2
9	Temperatura de economia de energia para ventilação	25°C~30°C	28°C
10	Modo de cartão de sala / cartão de janela	SC: ativa o modo de energia do cartão da sala por circuito aberto OC: ativa o modo de energia do cartão da sala por circuito fechado SCC: ativar o modo de energia da placa da janela de circuito aberto OCC: ativa o modo de energia da placa da janela de circuito fechado OO: cancela a função do cartão da sala / janela	SC
11	Válvula inicia opções de faixa morta	1°C~5°C	1°C
12	A válvula para opções de operação	1°C~5°C	1°C

Parâmetro Item	Descrição do produto	Opções de Parâmetros	Por padrão
13	Configuração do ciclo de atraso de redefinição do compressor	0min~5min	3min
14	O endereço de 485	1~254	1

Menu de configuração: sistema de dois compressores

Dois compressores de refrigeração do sistema:

Aplicativo 1: (página 8)

Ventilador de 3 velocidades /
sistema de dois compressores

(seleção do sistema: CP2-COL-SP3)

Aplicativo 4: (página9)

ventilador de uma velocidade /
sistema de dois compressores

(seleção do sistema: CP2-COL-SP1)

Parâmetro Item	Descrição do produto	Opções de Parâmetros	Por padrão
4	Programação	Pr0: não programável Pr2: dias úteis + sexta e sábado Pr7: programa individual de 7 dias	Pr0
5	Valor de ajuste da temperatura	-4°C~4°C	0
6	Temperatura máxima	24°C~35°C	30°C
7	Temperatura mínima	5°C~24°C	20°C
8	Desconectar la memoria	rE: recuperar memória ao ligar rd: recuperar a memória desligada ao ligar	rE

Parâmetro Item	Descrição do produto	Opções de Parâmetros	Por padrão
9	Mostrar modo de luz de fundo	1: a luz de fundo é normal 2: a luz de fundo sempre permanece acesa	2
10	Temperatura de economia de energia para ventilação	25°C~30°C	28°C
11	Modo de cartão de sala / cartão de janela	SC: ativa o modo de energia do cartão da sala por circuito aberto OC: ativa o modo de energia do cartão da sala por circuito fechado SCC: ativar o modo de energia da placa da janela de circuito aberto OCC: ativa o modo de energia da placa da janela de circuito fechado OO: cancela a função do cartão da sala / janela	SC
12	Válvula inicia opções de faixa morta	1°C~5°C	1°C
13	A válvula para opções de operação	1°C~5°C	1°C

Parâmetro Item	Descrição do produto	Opções de Parâmetros	Por padrão
14	A primeira válvula redefine a configuração do ciclo de atraso	0min~5min	3 min
15	O segundo compressor inicia opções de banda morta	1°C~5°C	1°C
16	As opções do segundo compressor param de funcionar	1°C~5°C	1°C
17	A segunda válvula redefine a configuração do ciclo de atraso	0min~5min	3 min
18	A segunda válvula inicia a configuração do ciclo de atraso	0min~5min	1 min
19	O endereço de 485	1~254	1

 Para os artigos 15 e 16, a temperatura de parada operacional não pode ser superior à temperatura inicial da banda morta

Sistema de dois compressores: aquecimento / resfriamento:
 Aplicativo 5: (página 10)
 ventilador de velocidade única / 2 sistemas de aquecimento / frio
 (seleção do sistema: CP2-ALL)

Parâmetro Item	Descrição do produto	Opções de Parâmetros	Por padrão
3	Programação	Pr0: não programável Pr2: dias úteis + sexta e sábado Pr7: programa individual de 7 dias	Pr0
4	Valor de ajuste de temperatura	-4°C~4°C	0
5	Temperatura máxima	24°C~35°C	30°C
6	Temperatura mínima	5°C~24°C	20°C
7	Desconectar memória	rE: recuperar memória ao ligar rd: recuperar a memória desligada ao ligar	rE

Parâmetro Item	Descrição do produto	Opções de Parâmetros	Por padrão
8	Mostrar modo de luz de fundo	1: a luz de fundo é normal 2: a luz de fundo sempre permanece acesa	2
9	Temperatura de economia de energia para aquecimento.	5°C~18°C	18°C
10	Temperatura de economia de energia para ventilação	25°C~30°C	28°C
11	Modo de cartão de sala / cartão de janela	SC: ativa o modo de energia do cartão da sala por circuito aberto OC: ativa o modo de energia do cartão da sala por circuito fechado SCC: ativar o modo de energia da placa da janela de circuito aberto OCC: ativa o modo de energia da placa da janela de circuito fechado OO: cancela a função do cartão da sala / janela	SC
12	Válvula inicia opções de faixa morta	1°C~5°C	1°C

Parâmetro Item	Descrição do produto	Opções de Parâmetros	Por padrão
13	As primeiras opções de compressor param de funcionar	1°C~5°C	1°C
14	A primeira válvula redefine a configuração do ciclo de atraso	0min~5min	3 min
15	O segundo compressor inicia opções de banda morta	1°C~5°C	1°C
16	As opções do segundo compressor param de funcionar	1°C~5°C	1°C
17	A segunda válvula redefine a configuração do ciclo de atraso	0min~5min	3 min
18	A segunda válvula inicia a configuração do ciclo de atraso	1min~5min	1 min
19	O endereço de 485	1~254	1

Aviso de erro



Temperatura ambiente (sensor interno da sala) quebrado ou atalho, termostato terá "**Err**"

Cartão de janela / quarto

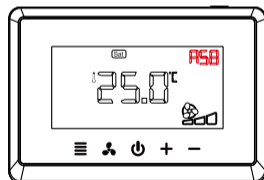

Função de cartão de janela aberta, o termostato terá "**ASB**"

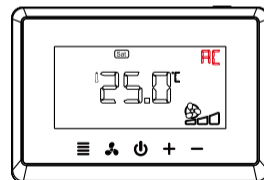

Função de cartão de sala aberta, o termostato terá "**AC**"

Product Introduction	
Specifications -----	02
Thermostat's Appearance-----	03
Installation and Programming	
Thermostat Installation -----	04
First Time Setting -----	05
System Setting -----	06
The Wiring Diagram -----	08
Programming Settings -----	12
Fan Speed Setting -----	21
Cooling and Heating Modes -----	22
Child Lock -----	23
Configuration Menu -----	24
Errod Warning -----	37
Window/Room Card -----	37

KTFD-29

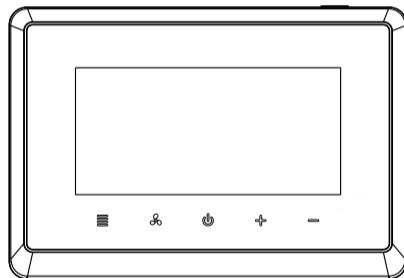

Specifications

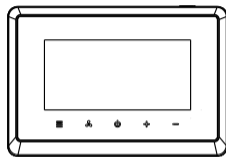

(KTFD-29)
thermostat

- Power source : 100-240VAC 50/60Hz
18-30VAC 50/60Hz
- IP Rating : IP21
- Temperature setting range : 5°C~35°C
- Temperature setting accuracy: 0.5°C
- Temperature display range :0°C~50°C
- Temperature accuracy : 0.1°C
- Operation temperature range : 0°C~50°C
- Shipping & storage temperature : -10°C ~ 60°C
- Output : Fan Relay Load I_{max} 250V/8(5)A
Compressor/Valve Relay Load I_{max} 250V/5(3)A

Thermostat's appearance

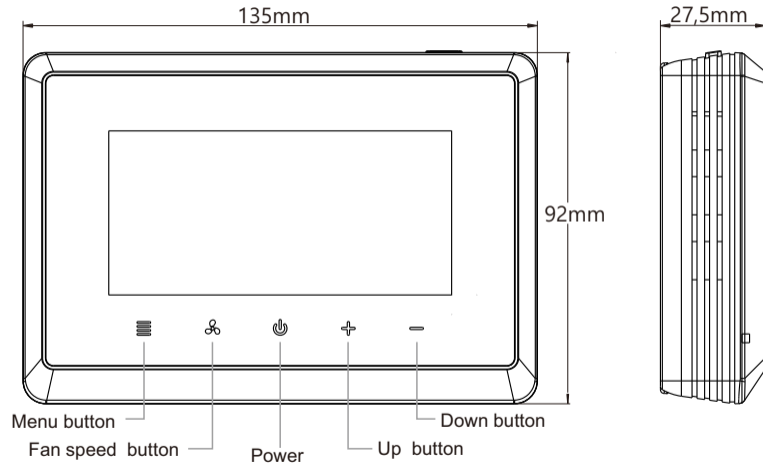

Thermostat Installation

1. Unscrew terminal protective jacket then wiring.

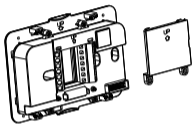

2. After wired the terminal protective jacket install the screw.

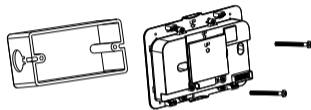

3. Install and fasten foundation, embed in display module.

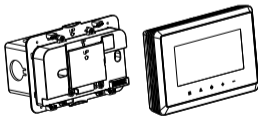

4. Installation finished.

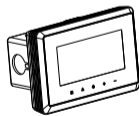

First Time Setting

Set the current actual time and week.

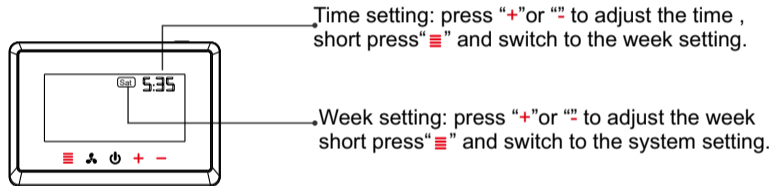

System Setting

(Multistage system)



1. press "+" or "-" to select the primary system .

CP1:single stage DX system
CP2:two stage DX system
FAN:Fan coil system

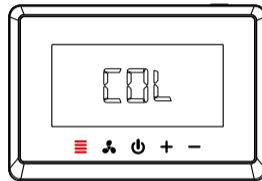

2. press "≡" to confirm the selection and switch to secondary system selection.

COL:cooling system
ALL:heat /cool system

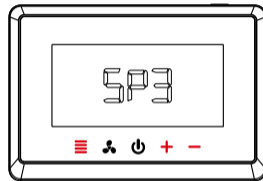

3. Select secondary and tertiary systems in the same way as above.

(If there is a need to select the tertiary system)
SP1:single speed fan
SP3:3 speed fan

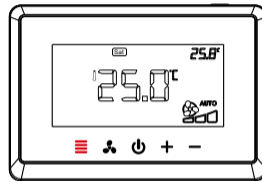

4. System setup completed, press "≡" to return to the main interface

The Wiring Diagram

Different wiring diagram correspond to different systems

Application 1:
3 speed fan/
two stage DX system
(system selection: **CP2-COL-SP3**)

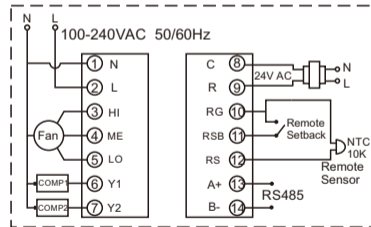

Application 2:
3 speed fan/
single stage DX system
(system selection: **CP1-SP3**)

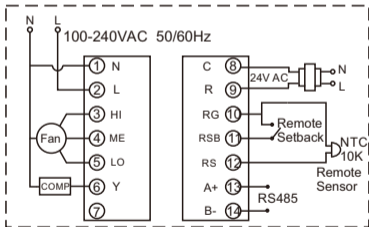

Application 3:
single speed fan/
single stage DX system
(system selection: **CP1-SP1**)

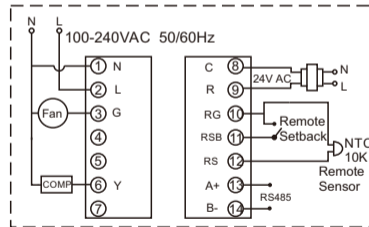

Application 4:
single speed fan/
two stage DX system
(system selection: **CP2-COL-SP1**)

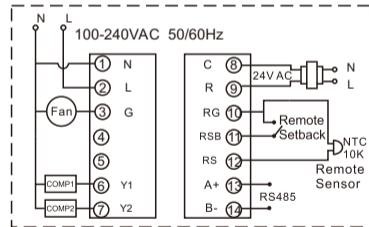

Application 5:
single speed fan /
2 heat/cool system
(system selection: **CP2-ALL**)

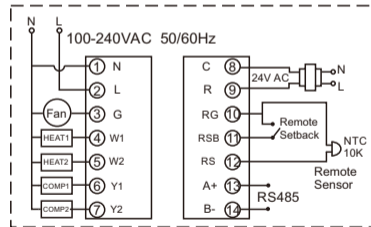

Application 6:
2 pipe/3 wire fan coil system
(system selection: **FAN-FA2**)

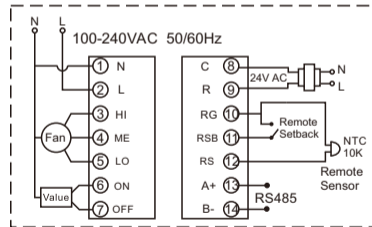

Application 7:
4 pipe/2 wire fan coil system
(system selection: **FAN-FA4**)

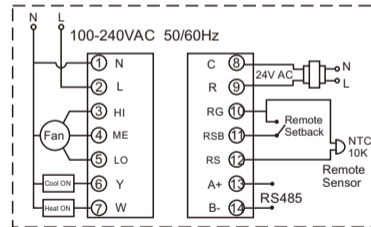

Application 8:
Single cool/
3 wire fan coil system
(system selection: **FAN-COL**)

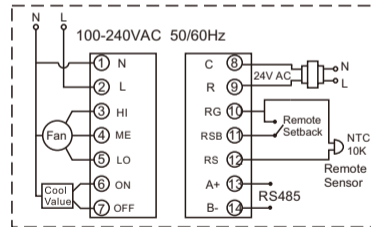

Programming Settings

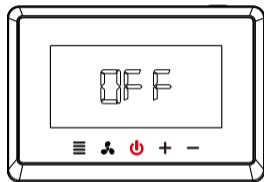

1. Short press the power button “”, and then the screen shows “OFF”.



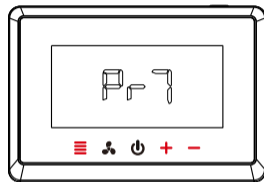

2. Long press the menu button “” for 5s until the system selection interface is displayed and select the system set up previously .

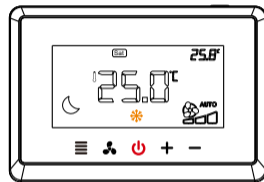

3. After system selection, select programming mode: press “+” or “-” for switch the programming mode (Pr0/Pr2/Pr7), and press “” to confirm and save the options.
Pr0: Non-programmable
Pr2: Work days+Friday&Saturday
Pr7: 7 days individually programming



4. Short press the power button “”, and the screen shows “OFF”, then short press the power button “” again to enter the programming main interface

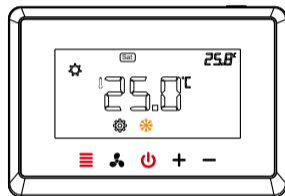

5. Long press the menu button “≡” for 5s to enter the programming setting.
 please Keep all the buttons lights on before performing this operation, if not, please press “⏻”

7 days programming-Time/temperature setting

Separate programming settings for each day (Pr7)
 (the programming setting are different from Sunday to Monday)

The are 4 periods each day by default

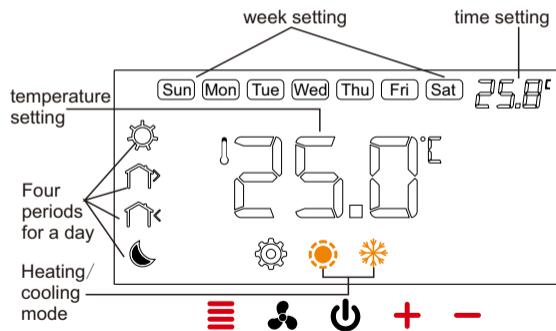





1. Week setting
2. Time setting
3. Temperature setting

press “+”“-” to adjust the week / time / temperature, short short press “≡” to save the setting and switch to next period setting.

***** long press “≡” for 5s to switch the heating mode or cooling mode

Default setting (heating)





week periods	Sun	Mon	Tue	Wed	Thu	Fri	Sat
 6:00 Morning	22°C	22°C	22°C	22°C	22°C	22°C	22°C
 8:00 Out door	16°C	16°C	16°C	16°C	16°C	16°C	16°C
 18:00 Back home	22°C	22°C	22°C	22°C	22°C	22°C	22°C
 22:00 Night	16°C	16°C	16°C	16°C	16°C	16°C	16°C



Exit programming settings : short press power button “

16

Default setting (cooling)

week periods	Sun	Mon	Tue	Wed	Thu	Fri	Sat
 6:00 Morning	25°C	25°C	25°C	25°C	25°C	25°C	25°C
 8:00 Out door	28°C	28°C	28°C	28°C	28°C	28°C	28°C
 18:00 Back home	25°C	25°C	25°C	25°C	25°C	25°C	25°C
 22:00 Night	28°C	28°C	28°C	28°C	28°C	28°C	28°C



Restore default setting: long press “+” and “-” for more than 5s until the screen shows “DEF” and the “DEF” flash 3 times.

2 periods programming-Time/temperature setting

There are two time periods to program in a week (Pr2)
 (period 1:from Sunday to Thursday
 period 2:from Friday to Saturday)

The are 4 periods each day by default

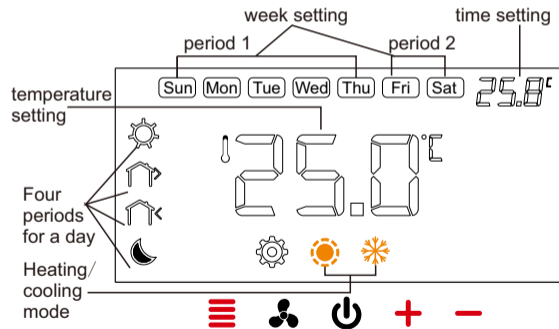

1. Week setting
2. Time setting
3. Temperature setting

press “+”“-” to adjust the week / time / temperature, short press “≡” to save the setting and switch to next period setting.



long press “≡” for 5s to switch the heating mode or cooling mode

Default setting (heating)

week periods	Sun	Mon	Tue	Wed	Thu	Fri	Sat
6:00 Morning			22°C				22°C
8:00 Out door			16°C				16°C
18:00 Back home			22°C				22°C
22:00 Night			16°C				16°C



Exit programming settings : press power button “⏻”
 Return to the previous step : short press fan speed button “🌀”

Default setting (cooling)

week periods	Sun	Mon	Tue	Wed	Thu	Fri	Sat
6:00 Morning			25°C				25°C
8:00 Out door			28°C				28°C
18:00 Back home			25°C				25°C
22:00 Night			28°C				28°C



Restore default setting: long press “+” and “-” for more than 5s until the screen shows “DEF” and the “DEF” flash 3 times.

Fan speed setting

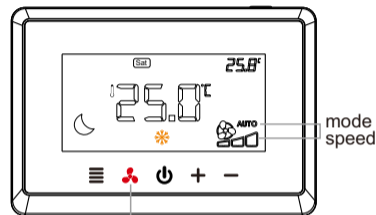

Fan speed button

mode speed

Fan speed mode setting : short press “” for switching “AUTO” or “ON” mode.

AUTO: Automatic mode
(High speed, Med speed, Low speed)
ON: Manual mode

Cooling and Heating Modes

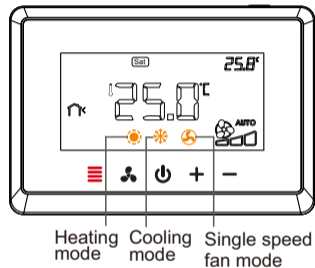

Short press the menu button “≡” for switching cooling mode “❄️” or heating mode “☀️” or single speed fan mode “🌀”

Child Lock

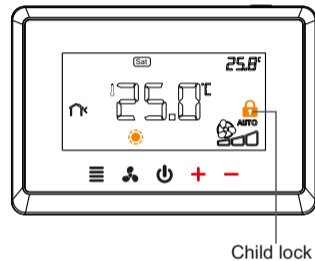

Press the “+” and “-” buttons for 5s at the same time to open / close the child lock “🔒”.

Configuration Menu

The configuration menu setting :

1. In the state of shutdown, long press menu button “≡” for 5s to enter the configuration parameter programming setting.

2. Press “+” or “-” to select the configuration parameter setting, then press “≡” to save and switch to the next item setting.

3. After all the parameters are set up, press power button “⏻” exit the setting and return to the OFF stage.

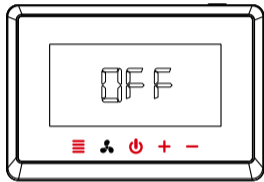

- * 1. The thermostat will exit the configuration parameter setting automatically and return to the shutdown state if there is no any operation within 30s.
- 2. Restore default setting: during setup, long press “+” and “-” for more than 5s until the screen shows “DEF” and the “DEF” flash 3 times.

Configuration Menu-FAN coil system

Fan coil system:

Application 6: (page10)
2 pipe/3 wire fan coil system
(system selection: **FAN-FA2**)

Application 7: (page11)
4 pipe/2 wire fan coil system
(system selection: **FAN-FA4**)

Application 8: (page12)
Single cool/
3 wire fan coil system
(system selection: **FAN-COL**)

Parameter Item	Description	Parameter options	Default
3	Programming	Pr0:Non-programmable Pr2:Work days+Friday&Saturday Pr7:7 days individually program	Pr0
4	Temperature adjust value	-4°C~4°C	0
5	Maximum setting temperature	24°C~35°C	30°C
6	Minimum setting temperature	5°C~24°C	20°C
7	Power off memory	rE: power on recover rd: power on turn off	rE

Parameter Item	Description	Parameter options	Default
8	Display backlight mode	1:backlight is normal 2:backlight will keep on always	2
9	Fan stop option	ON OFF	ON
10	Energy-saving temperature for heating	5°C~18°C	18°C
11	Energy-saving temperature for cooling	25°C~30°C	28°C
12	Room card/windowdown card mode	SC : activate the room card energy mode by open circuit OC : activate the room card energy mode by close circuit SCC : activate the windowdown card energy mode by open circuit OCC : activate the windowdown card energy mode by close circuit OO : cancel the room/windowdown card function	SC
13	The valve start dead band options	1°C~5°C	1°C

Parameter Item	Description	Parameter options	Default
14	The valve stop running options	1°C~5°C	1°C
15	The address of 485	1~254	1

 There is no **item 10** (Energy-saving temperature for heating) for Single cool / 3 wire fan coil system (Application 8, **FAN-COL**)

Configuration Menu-Single compressor system

Single compressor system:

Application 2: (page8)

3 speed fan/
single compressor system

(system selection: **CP1-SP3**)

Application 3: (page9)

single speed fan/
single compressor system

(system selection: **CP1-SP1**)

Parameter Item	Description	Parameter options	Default
3	Programming	Pr0:Non-programmable Pr2:Work days+Friday&Saturday Pr7:7 days individually program	Pr0
4	Temperature adjust value	-4°C~4°C	0
5	Maximum setting temperature	24°C~35°C	30°C
6	Minimum setting temperature	5°C~24°C	20°C
7	Power off memory	rE: power on recover rd: power on turn off	rE

Parameter Item	Description	Parameter options	Default
8	Display backlight mode	1:backlight is normal 2:backlight will keep on always	2
9	Energy-saving temperature for cooling	25°C~30°C	28°C
10	Room card/window card mode	SC : activate the room card energy mode by open circuit OC : activate the room card energy mode by close circuit SCC : activate the window card energy mode by open circuit OCC : activate the window card energy mode by close circuit OO : cancel the room/window card function	SC
11	The valve start dead band options	1°C~5°C	1°C
12	The valve stop running options	1°C~5°C	1°C

Parameter Item	Description	Parameter options	Default
13	Compressor restart delay cycle setting	0min~5min	3min
14	The address of 485	1~254	1

Configuration Menu-two compressor system

Two compressor system-cooling:

Application 1: (page8)

3 speed fan/
two compressor system

(system selection: **CP2-COL-SP3**)

Application 4: (page9)

single speed fan/
two compressor system

(system selection: **CP2-COL-SP1**)

Parameter Item	Description	Parameter options	Default
4	Programming	Pr0:Non-programmable Pr2:Work days+Friday&Saturday Pr7:7 days individually program	Pr0
5	Temperature adjust value	-4°C~4°C	0
6	Maximum setting temperature	24°C~35°C	30°C
7	Minimum setting temperature	5°C~24°C	20°C
8	Power off memory	rE: power on recover rd: power on turn off	rE

Parameter Item	Description	Parameter options	Default
9	Display backlight mode	1:backlight is normal 2:backlight will keep on always	2
10	Energy-saving temperature for cooling	25°C~30°C	28°C
11	Room card/window card mode	SC : activate the room card energy mode by open circuit OC : activate the room card energy mode by close circuit SCC : activate the window card energy mode by open circuit OCC : activate the window card energy mode by close circuit OO : cancel the room/window card function	SC
12	The first compressor start dead band options	1°C~5°C	1°C
13	The first compressor stop running options	1°C~5°C	1°C

Parameter Item	Description	Parameter options	Default
14	The first compressor restart delay cycle setting	0min~5min	3min
15	The second compressor start dead band options	1°C~5°C	1°C
16	The second compressor stop running options	1°C~5°C	1°C
17	The second compressor restart delay cycle setting	0min~5min	3min
18	The second compressor start delay cycle setting	1min~5min	1min
19	The address of 485	1~254	1

 For **items 15 and 16**, the stop running temperature can not be greater than the starting dead band temperature

Two compressor system-heating/cooling:

Application 5: (page10)

single speed fan /2 heat/cool system

(system selection: CP2-ALL)

Parameter Item	Description	Parameter options	Default
3	Programming	Pr0:Non-programmable Pr2:Work days+Friday&Saturday Pr7:7 days individually program	Pr0
4	Temperature adjust value	-4°C~4°C	0
5	Maximum setting temperature	24°C~35°C	30°C
6	Minimum setting temperature	5°C~24°C	20°C
7	Power off memory	rE: power on recover rd: power on turn off	rE

Parameter Item	Description	Parameter options	Default
8	Display backlight mode	1:backlight is normal 2:backlight will keep on always	2
9	Energy-saving temperature for heating	5°C~18°C	18°C
10	Energy-saving temperature for cooling	25°C~30°C	28°C
11	Room card/windowdown card mode	SC : activate the room card energy mode by open circuit OC : activate the room card energy mode by close circuit SCC : activate the windowdown card energy mode by open circuit OCC : activate the windowdown card energy mode by close circuit OO : cancel the room/windowdown card function	SC
12	The first compressor start dead band options	1°C~5°C	1°C

Parameter Item	Description	Parameter options	Default
13	The first compressor stop running options	1°C~5°C	1°C
14	The first compressor restart delay cycle setting	0min~5min	3min
15	The second compressor start dead band options	1°C~5°C	1°C
16	The second compressor stop running options	1°C~5°C	1°C
17	The second compressor restart delay cycle setting	0min~5min	3min
18	The second compressor start delay cycle setting	1min~5min	1min
19	The address of 485	1~254	1

Errod Warning



Room Temp(inside room sensor) broken or short cut,the thermostat will have "Err"

Window/Room Card



Window card function open, the thermostat will have "ASB"

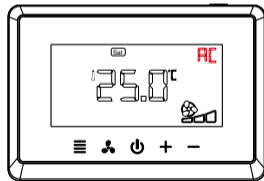

Room card function open, the thermostat will have "AC"

Présentation du produit

Spécifications ----- 02

Apparence du thermostat ----- 03

Installation et programmation

Installation du thermostat ----- 04

Première configuration ----- 05

Configuration du système ----- 06

Schéma de câblage ----- 08

Paramètres de programmation ----- 12

Réglage de la vitesse du ventilateur ----- 21

Modes de refroidissement et de chauffage --- 22

Sécurité enfants ----- 23

Menu de configuration ----- 24

Avertissement d'erreur ----- 37

Carte fenêtre / chambre ----- 37

KTFD-29

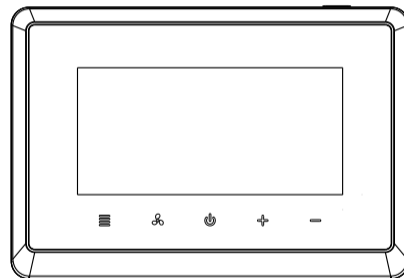

Spécifications techniques

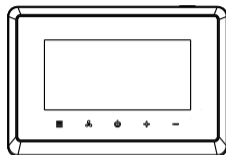

(KTFD-29)
thermostat

- Source d'alimentation: 100-240VAC 50 / 60Hz
18-30VAC 50 / 60Hz
- Indice IP: IP21
- Plage de réglage de la température: 5 °C ~ 35 °C
- Précision de réglage de la température: 0,5 °C
- Plage d'affichage de la température: 0 °C ~ 50 °C
- Précision de la température: 0,1 °C
- Plage de température de fonctionnement: 0 °C ~ 50 °C
- Température d'expédition et de stockage: -10 °C ~ 60 °C
- Sortie: Charge de relais de ventilateur I_{max} 250V / 8 (5) A
Charge du compresseur / relais de valve I_{max} 250V / 5 (3) A

Apparence du thermostat

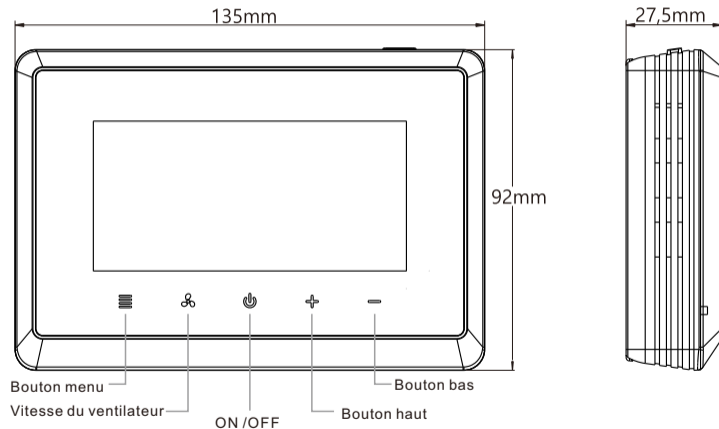

Installation du thermostat

1. Dévissez la borne de protection du couvercle, puis le câblage.

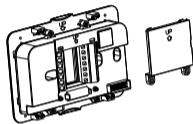

2. Après le câblage, couvrez la borne avec le couvercle de protection, installez la vis.

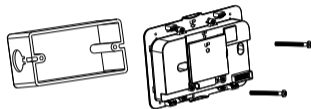

3. Installez et fixez la base, intégrée dans le module d'affichage.

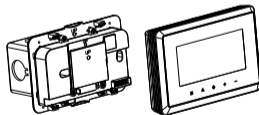

4. Installation terminée.

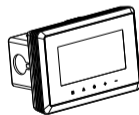

Premier ajustement

Réglez l'heure et la semaine actuelles.

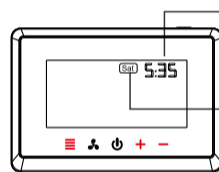

Réglage de l'heure: Appuyez sur "+" ou "-" pour régler l'heure, appuyez brièvement sur "☰" et passez au réglage de la semaine.

Réglage de la semaine: appuyez sur "+" ou "-" pour régler la semaine, appuyez brièvement sur "☰" et passez aux paramètres système.

Configuration système

(Système de choix de fonction)

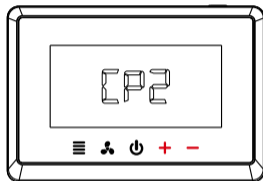

1. Appuyez sur "+" ou "-" pour Sélectionner le système principal.
CP1: système DX à un étage
CP2: système DX à deux étages
FAN: système de ventilo-convecteur

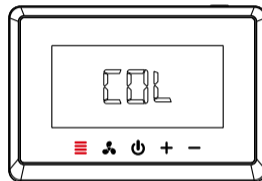

2. Appuyez sur “☰” pour confirmer la sélection et passer à la sélection du système secondaire.
COL: système de refroidissement
TOUS: système chaud / froid

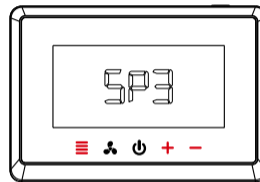

3. Sélectionnez les systèmes secondaire et tertiaire de la même manière que ci-dessus. (Si nécessaire, sélectionnez le système tertiaire)
SP1: ventilateur à une vitesse
SP3: ventilateur à 3 vitesses

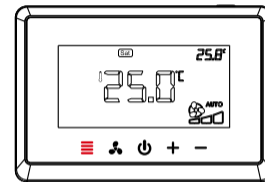

4. Configuration du système terminée, appuyez sur “☰” pour revenir à l'interface principale

Schéma de câblage

Différents schémas de câblage correspondent à différents systèmes

Application 1:
Ventilateur 3 vitesses /
système DX à deux étages
(sélection du système: CP2-COL-SP3)

Application 2:
Ventilateur 3 vitesses /
système DX à un étage
(sélection du système: CP1-SP3)

Application 3:
ventilateur à une vitesse /
système DX à un étage
(sélection du système: CP1-SP1)

Application 4:
ventilateur à une vitesse /
système DX à deux étages
(sélection du système: CP2-COL-SP1)

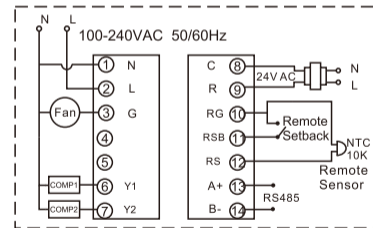
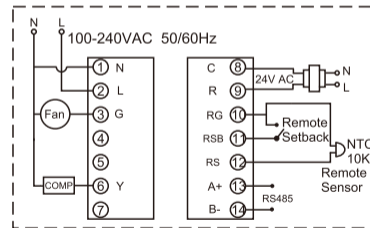
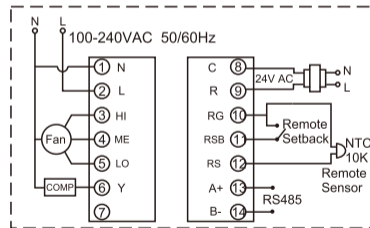
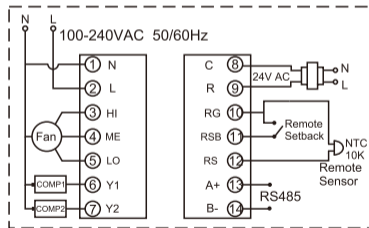

Application 5:
ventilateur à une vitesse /
2 système de chauffage / froid
(sélection du système: CP2-ALL)

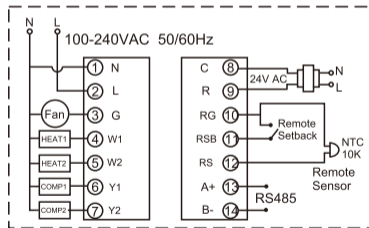

Application 6:
Ventilo-convecteur 2 tubes / 3 fils
(sélection du système: FAN-FA2)

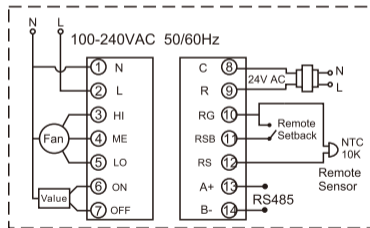

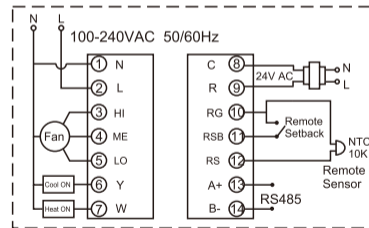

Application 7:
Ventilo-convecteur 4 tubes / 2 fils
(sélection du système: FAN-FA4)



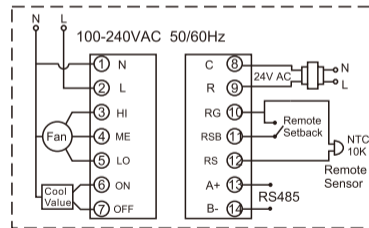

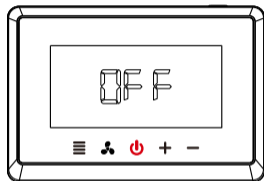
Application 8:
Simple cool / Système de
ventilo-convecteur à 3 fils
(sélection du système: FAN-COL)





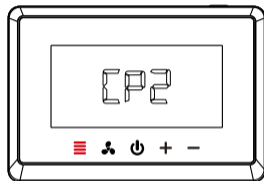

1. Appuyez brièvement sur le bouton d'alimentation "  ", puis l'écran affiche "OFF".



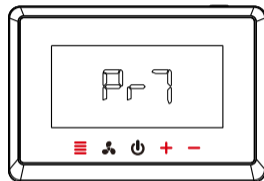

2. Appuyez sur le bouton de menu "  " et maintenez-le enfoncé pendant 5 secondes jusqu'à ce que l'interface de sélection du système s'affiche et sélectionnez au préalable la configuration du système.

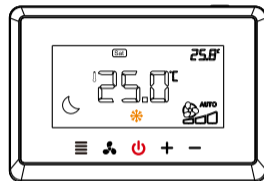

3. Après avoir sélectionné le système, sélectionnez le mode de programmation: appuyez sur "+" ou "-" pour changer le mode de programmation (Pr0 / Pr2 / Pr7), et appuyez sur "  " pour confirmer et enregistrer les options.
Pr0: non programmable
Pr2: jours ouvrables + vendredi et samedi
Pr7: 7 jours de programmation individuelle



4. Appuyez brièvement sur le bouton d'alimentation "  " et l'écran affiche "OFF", puis appuyez à nouveau brièvement sur le bouton d'alimentation "  " pour accéder à l'interface de programmation principale.

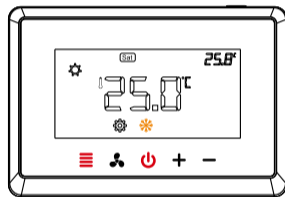

5. Appuyez sur le bouton de menu "☰" et maintenez-le enfoncé pendant 5 secondes pour accéder aux paramètres de programmation. laissez tous les voyants allumés avant d'effectuer cette opération; sinon, appuyez sur "⏻"

Programmation 7 jours: réglage heure / température

Configuration hebdomadaire Paramètres de programmation séparés pour chaque jour (Pr7) (la configuration de programmation est différente du dimanche au lundi)
Configuration hebdomadaire Il y a 4 périodes par jour par défaut

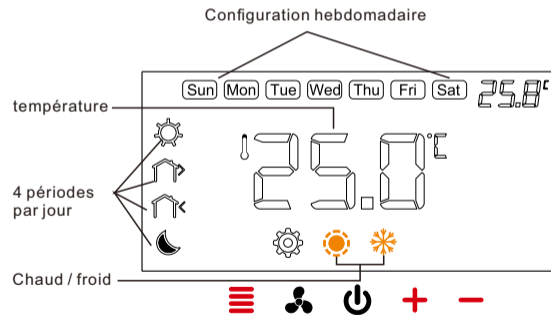







1. Configuration hebdomadaire
2. réglage de l'heure
3. ajustement de la température

appuyez sur "+" "-" pour régler la semaine / heure / température, appuyez brièvement sur "☰" pour enregistrer le réglage et passer au réglage de période suivant.





appuyez et maintenez "☰" pendant 5 secondes pour changer le mode de chauffage ou le mode de refroidissement

Réglage par défaut (chauffage)

week periods	Sun	Mon	Tue	Wed	Thu	Fri	Sat
 6:00 Morning	22°C	22°C	22°C	22°C	22°C	22°C	22°C
 8:00 Out door	16°C	16°C	16°C	16°C	16°C	16°C	16°C
 18:00 Back home	22°C	22°C	22°C	22°C	22°C	22°C	22°C
 22:00 Night	16°C	16°C	16°C	16°C	16°C	16°C	16°C

✳️ Quitter les paramètres de programmation: appuyez brièvement sur le bouton d'alimentation “”
Revenez à l'étape précédente: appuyez brièvement sur le bouton de vitesse du ventilateur “”

Réglage par défaut (refroidissement)

week periods	Sun	Mon	Tue	Wed	Thu	Fri	Sat
 6:00 Morning	25°C	25°C	25°C	25°C	25°C	25°C	25°C
 8:00 Out door	28°C	28°C	28°C	28°C	28°C	28°C	28°C
 18:00 Back home	25°C	25°C	25°C	25°C	25°C	25°C	25°C
 22:00 Night	28°C	28°C	28°C	28°C	28°C	28°C	28°C

✳️ Restaurer les paramètres par défaut: appuyez et maintenez "+" et "-" pendant plus de 5 secondes jusqu'à ce que l'écran affiche "**DEF**" et "**DEF**" clignote 3 fois.

Programmation 2 périodes: réglage heure / température

Il y a deux périodes à programmer dans une semaine (Pr2)

(période 1: du dimanche au jeudi

Période 2: du vendredi au samedi) 4 périodes par jour

Il y a 4 périodes par jour par défaut

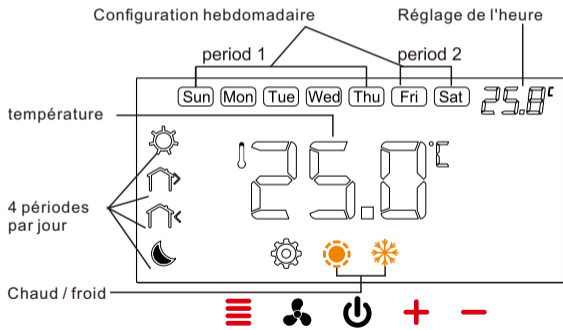

1. Configuration hebdomadaire
2. réglage de l'heure
3. ajustement de la température

appuyez sur "+" "-" pour régler la semaine / heure / température, appuyez brièvement sur "☰" pour enregistrer le réglage et passer au réglage de période suivant.

Appuyez et maintenez "☰" pendant 5 secondes pour changer le mode de chauffage ou le mode de refroidissement

Réglage par défaut (chauffage)

week periods	Sun	Mon	Tue	Wed	Thu	Fri	Sat
6:00 Morning			22°C				22°C
8:00 Out door			16°C				16°C
18:00 Back home			22°C				22°C
22:00 Night			16°C				16°C

* Quitter les paramètres de programmation: appuyez sur le bouton d'alimentation "🔌" Revenez à l'étape précédente: appuyez brièvement sur le bouton de vitesse du ventilateur "🌀"

Réglage par défaut (refroidissement)

week periods	Sun	Mon	Tue	Wed	Thu	Fri	Sat
6:00 Morning			25°C				25°C
8:00 Out door			28°C				28°C
18:00 Back home			25°C				25°C
22:00 Night			28°C				28°C

★ Restaurer les paramètres par défaut: appuyez et maintenez "+" et "-" pendant plus de 5 secondes jusqu'à ce que l'écran affiche "DEF" et "DEF" clignote 3 fois.

Réglage de la vitesse du ventilateur

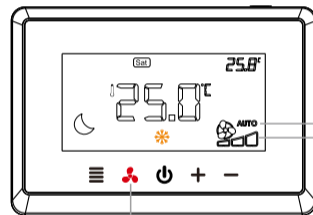

Réglage du mode de vitesse du ventilateur: appuyez brièvement sur "☘" pour changer le mode "AUTO" ou "ON".

Mode vitesse

Bouton de sélection de vitesse

AUTO: mode automatique
(Haute vitesse, vitesse moyenne, basse vitesse)
ON: mode manuel

Modes de refroidissement et de chauffage

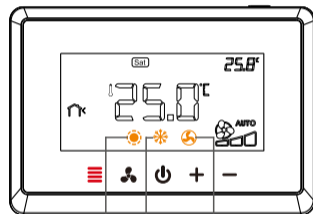

Appuyez brièvement sur le bouton de menu "☰" pour changer le mode de refroidissement "☀❄️" ou le mode de chauffage "☀️" ou le mode de ventilateur à vitesse unique "🌀"

Mode chauffage

Mode de ventilation

Vitesse de ventilateur unique

Sécurité enfants

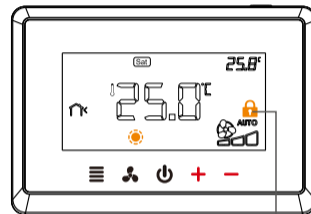

Assurance enfant

Appuyez sur les boutons "+" et "-" pendant 5 secondes en même temps pour ouvrir / fermer la sécurité enfants "🔒".

Menu de configuration

Le réglage du menu des paramètres:

1. Dans l'état d'arrêt, appuyez et maintenez le bouton de menu "☰" pendant 5 secondes pour entrer les paramètres de programmation des paramètres de configuration.
2. Appuyez sur "+" ou "-" pour sélectionner le paramètre de configuration, puis appuyez sur "☰" pour enregistrer et passer au paramètre d'élément suivant.
3. Après avoir configuré tous les paramètres, appuyez sur le bouton d'alimentation "⏻" pour quitter la configuration et revenir à l'étape d'arrêt.

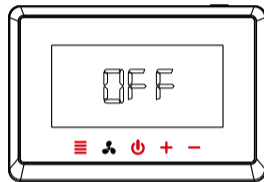

- * 1. Le thermostat quitte automatiquement le réglage des paramètres de configuration et revient à l'état désactivé si aucune opération n'est effectuée pendant 30 secondes.
- 2. Restaurez les paramètres par défaut: pendant la configuration, appuyez et maintenez "+" et "-" pendant plus de 5 secondes jusqu'à ce que l'écran affiche "dEF" et "dEF" clignote 3 fois.

Menu de configuration: système Fancoil

Système de ventilo-convecteur:
Application 6: (page 10)
Ventilo-convecteur 2 tubes / 3 fils
(sélection du système: FAN-FA2)

Application 7: (page 11)
Ventilo-convecteur 4 tubes / 2 fils
(sélection du système:
FAN-FA4)

Application 8: (page 12)
Système de ventilo-convecteur
de refroidissement simple / 3 fils
(sélection du système: FAN-COL)

paramètre Article	La description	Options des paramètres	Par défaut
3	Programmation	Pr0: non programmable Pr2: jours ouvrables + vendredi et samedi Pr7: programme individuel de 7 jours	Pr0
4	Valeur de réglage de la température	-4°C~4°C	0
5	Température maximale	24°C~35°C	30°C
6	Température minimale	5°C~24°C	20°C
7	Déconnectez la mémoire	rE: récupérer de la mémoire à la mise sous tension rd: récupérer la mémoire hors tension au démarrage	rE

Paramètre Article	La description	Options des paramètres	Par défaut
8	Afficher le mode de rétroéclairage	1: le rétro-éclairage est normal 2: le rétro-éclairage restera toujours allumé	2
9	Option d'arrêt du ventilateur	ON OFF	ON
10	Température d'économie d'énergie pour le chauffage.	5°C~18°C	18°C
11	Température d'économie d'énergie pour la ventilation	25°C~30°C	28°C
12	Mode carte de chambre / carte fenêtre	SC: activer le mode d'alimentation de la carte de chambre par circuit ouvert OC: active le mode d'alimentation de la carte de salle par circuit fermé SCC: activer le mode d'alimentation de la carte fenêtre en circuit ouvert OCC: activer le mode d'alimentation de la carte fenêtre en circuit fermé OO: annuler la fonction de carte de chambre / fenêtre	SC
13	La vanne démarre les options de zone morte	1°C~5°C	1°C

paramètre Article	La description	Options des paramètres	Par défaut
14	La valve cesse d'offrir des options	1°C~5°C	1°C
15	L'adresse du 485	1~254	1

 Aucun élément 10 (température d'économie d'énergie pour le chauffage) pour le système de ventilo-convecteur de refroidissement individuel / 3 fils (application 8, FAN-COIL)

Menu de configuration: système à compresseur unique

Système de compresseur simple:

Application 2: (page 8)

Ventilateur 3 vitesses /

système de compresseur unique

(sélection du système: CP1-SP3)

Application 3: (page 9)

ventilateur à une vitesse /

système de compresseur unique

(sélection du système: CP1-SP1)

Paramètre Article	La description	Options des paramètres	Par défaut
3	Programmation	Pr0: non programmable Pr2: jours ouvrables + vendredi et samedi Pr7: programme individuel de 7 jours	Pr0
4	Valeur de réglage de la température	-4°C~4°C	0
5	Température maximale	24°C~35°C	30°C
6	Température minimale	5°C~24°C	20°C
7	Déconnectez la mémoire	rE: récupérer de la mémoire à la mise sous tension rd: récupérer la mémoire hors tension au démarrage	rE

Paramètre Article	La description	Options des paramètres	Par défaut
8	Afficher le mode de rétroéclairage	1: le rétro-éclairage est normal 2: le rétro-éclairage restera toujours allumé	2
9	Température d'économie d'énergie pour la ventilation	25°C~30°C	28°C
10	Mode carte de chambre / carte fenêtre	SC: activer le mode d'alimentation de la carte de chambre par circuit ouvert OC: active le mode d'alimentation de la carte de salle par circuit fermé SCC: activer le mode d'alimentation de la carte fenêtre en circuit ouvert OCC: activer le mode d'alimentation de la carte fenêtre en circuit fermé OO: annuler la fonction de carte de chambre / fenêtre	SC
11	La vanne démarre les options de zone morte	1°C~5°C	1°C
12	La vanne arrête les options de fonctionnement	1°C~5°C	1°C

Paramètre Article	La description	Options des paramètres	Par défaut
13	Réglage du cycle de retard de réinitialisation du compresseur	0min~5min	3min
14	L'adresse du 485	1~254	1

Menu de configuration: système à deux compresseurs

Deux compresseurs de refroidissement du système:

Application 1: (page 8)
Ventilateur 3 vitesses /
système à deux compresseurs
(sélection du système: CP2-COL-SP3)

Application 4: (page9)
ventilateur à une vitesse /
système à deux compresseurs
(sélection du système: CP2-COL-SP1)

Paramètre Article	La description	Options des paramètres	Par défaut
4	Programmation	Pr0: non programmable Pr2: jours ouvrables + vendredi et samedi Pr7: programme individuel de 7 jours	Pr0
5	Valeur de réglage de la température	-4°C~4°C	0
6	Température maximale	24°C~35°C	30°C
7	Température minimale	5°C~24°C	20°C
8	Déconnectez la mémoire	rE: récupérer de la mémoire à la mise sous tension rd: récupérer la mémoire hors tension à la mise sous tension	rE

paramètre Article	La description	Options des paramètres	Par défaut
9	Afficher le mode de rétroéclairage	1: le rétro-éclairage est normal 2: le rétro-éclairage restera toujours allumé	2
10	Température d'économie d'énergie pour la ventilation	25°C~30°C	28°C
11	Mode carte de chambre / carte fenêtre	SC: activer le mode d'alimentation de la carte de chambre par circuit ouvert OC: active le mode d'alimentation de la carte de salle par circuit fermé SCC: activer le mode d'alimentation de la carte fenêtre en circuit ouvert OCC: activer le mode d'alimentation de la carte fenêtre en circuit fermé OO: annuler la fonction de carte de chambre / fenêtre	SC
12	La vanne démarre les options de zone morte	1°C~5°C	1°C
13	La valve arrête de fonctionner	1°C~5°C	1°C

paramètre Article	La description	Options des paramètres	Par défaut
14	La première vanne réinitialise le réglage du cycle de retard	0min~5min	3 min
15	Le deuxième compresseur démarre les options de zone morte	1°C~5°C	1°C
16	Les options du deuxième compresseur cessent de fonctionner	1°C~5°C	1°C
17	La deuxième vanne réinitialise le réglage du cycle de retard	0min~5min	3 min
18	La deuxième vanne démarre la configuration du cycle de retard	0min~5min	1 min
19	L'adresse du 485	1~254	1



Pour les articles 15 et 16, la température d'arrêt de fonctionnement ne peut pas être supérieure à la température de zone morte initiale

Système à deux compresseurs: chauffage / refroidissement:

Application 5: (page10)

ventilateur à une vitesse / 2 systèmes de chauffage / froid

(sélection du système: CP2-ALL)

paramètre Article	La description	Options des paramètres	Par défaut
3	Programmation	Pr0: non programmable Pr2: jours ouvrables + vendredi et samedi Pr7: programme individuel de 7 jours	Pr0
4	Valeur de réglage de la température	-4°C~4°C	0
5	Température maximale	24°C~35°C	30°C
6	Température minimale	5°C~24°C	20°C
7	Déconnectez la mémoire	rE: récupérer de la mémoire à la mise sous tension rd: récupérer la mémoire hors tension au démarrage	rE

paramètre Article	La description	Options des paramètres	Par défaut
8	Afficher le mode de rétroéclairage	1: le rétro-éclairage est normal 2: le rétro-éclairage restera toujours allumé	2
9	Température d'économie d'énergie pour le chauffage.	5°C~18°C	18°C
10	Température d'économie d'énergie pour la ventilation	25°C~30°C	28°C
11	Mode carte de chambre / carte fenêtre	SC: activer le mode d'alimentation de la carte de chambre par circuit ouvert OC: active le mode d'alimentation de la carte de salle par circuit fermé SCC: activer le mode d'alimentation de la carte fenêtre en circuit ouvert OCC: activer le mode d'alimentation de la carte fenêtre en circuit fermé OO: annuler la fonction de carte de chambre / fenêtre	SC
12	La vanne démarre les options de zone morte	1°C~5°C	1°C

paramètre Article	La description	Options des paramètres	Par défaut
13	Les premières options de compresseur cessent de fonctionner	1°C~5°C	1°C
14	La première vanne réinitialise le réglage du cycle de retard	0min~5min	3 min
15	Le deuxième compresseur démarre les options de zone morte	1°C~5°C	1°C
16	Les options du deuxième compresseur cessent de fonctionner	1°C~5°C	1°C
17	La deuxième vanne réinitialise le réglage du cycle de retard	0min~5min	3 min
18	La deuxième vanne démarre la configuration du cycle de retard	1min~5min	1 min
19	L'adresse du 485	1~254	1

Avertissement d'erreur



Température ambiante (sonde intérieure de la pièce) cassé ou raccourci, thermostat aura "**Err**"

Carte fenêtre / chambre

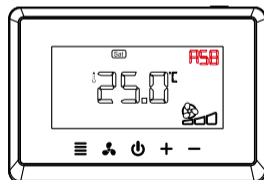

Fonction de carte de fenêtre ouverte, le thermostat aura "**ASB**"

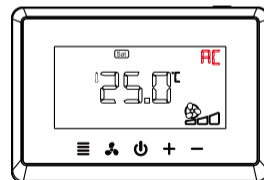

Fonction de carte de pièce ouverte, le thermostat aura "**AC**"